

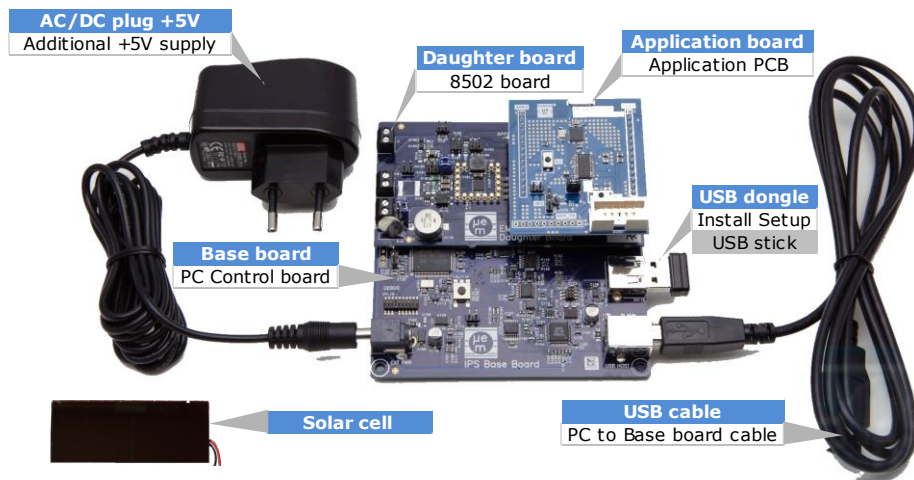

EMDVK8502 QUICK START GUIDE



Your EMDVK8502 Development Kit contains:

- | **EMDVK8500** Base Board – 8502 Daughter Board – Application Board
- | **USB Cable**
- | **Power-supply**
- | **USB Dongle** containing EM8500 DevExplorer software installation setup
- | **Solar cell**

Full documentation for **EMDVK8500** and **DevExplorer** is available on EM website (EMDVK8500 user guide)

https://www.emmicroelectronic.com/sites/default/files/products/files/user_guide_emdvk8500.pdf

This quick start document guides you through the set-up of your development hardware kit, software and demo.

1 INSTALL THE EM8500 DEVEXPLORER SOFTWARE TOOL FROM THE USB DONGLE

- | **Connect the USB memory stick** on the Base board (USB MEM connector)
- | **Connect the Base board** (USB Host) to the PC using the USB cable.
- | **Skip and close** the installation driver window that may pop-up.
- | **Open** an explorer window.
- | **Click** on the relevant **USB stick drive**.(EM8500 DevKit)
- | **Double click** on the **EM8500 DevExplorer setup executable file**.
This setup will guide you through the installation process.

Any additional questions? Please refer to the EMDVK8500 User Guide

2 CHECK THE DAUGHTER BOARD CONFIGURATION

- | **Place the jumpers** as shown below

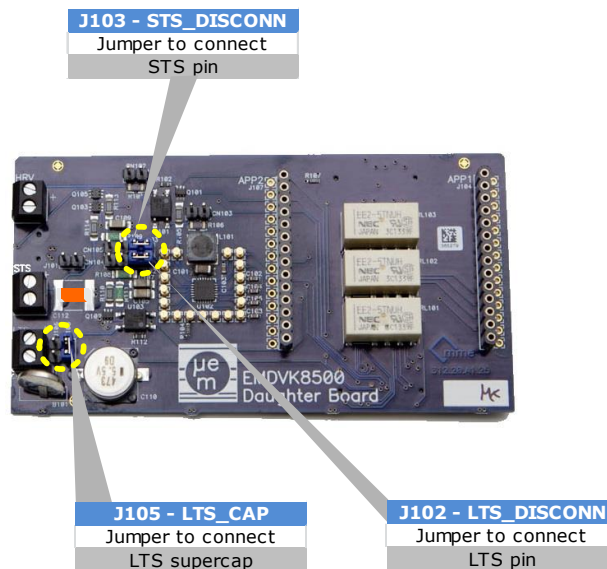

3 CONNECT THE SOLAR CELL TO THE HRV DAUGHTER BOARD SCREW TERMINAL

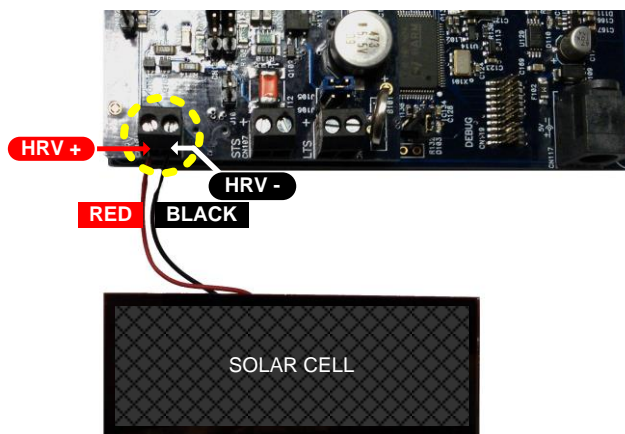

4 BUILD AND CONNECT THE SYSTEM TO THE PC

- | Plug the three boards together
- | Connect the USB cable
- | Connect the power-supply.

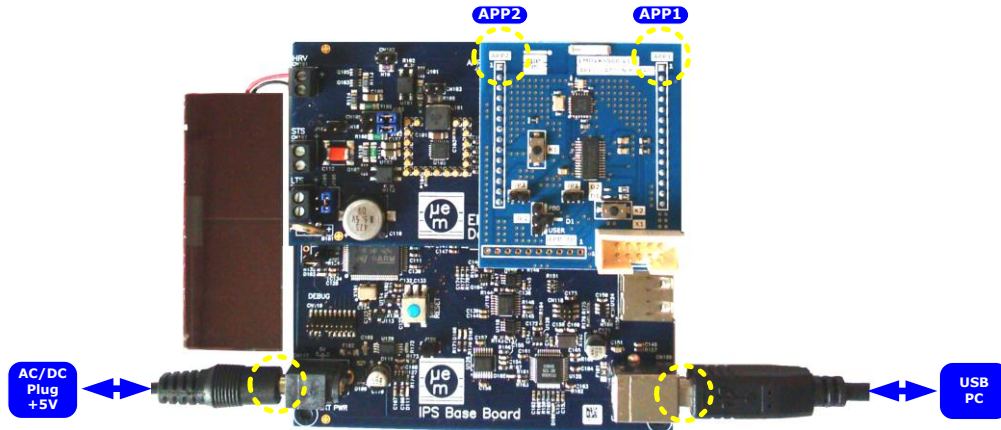

5 LAUNCH THE DEVEXPLORER SOFTWARE

- | Use the Start Menu shortcut EM8500 DevExplorer to launch the software.

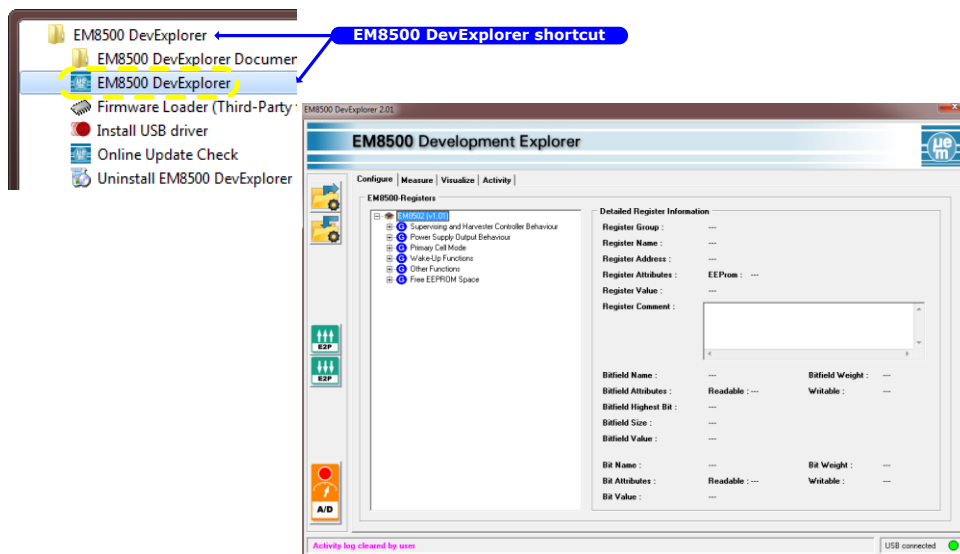

6 RUN THE DEMO

A default application demo is available on EMDVK8502.

- | Select the **Measure window**
- | Check that all the **switches and selectors** are set as shown below

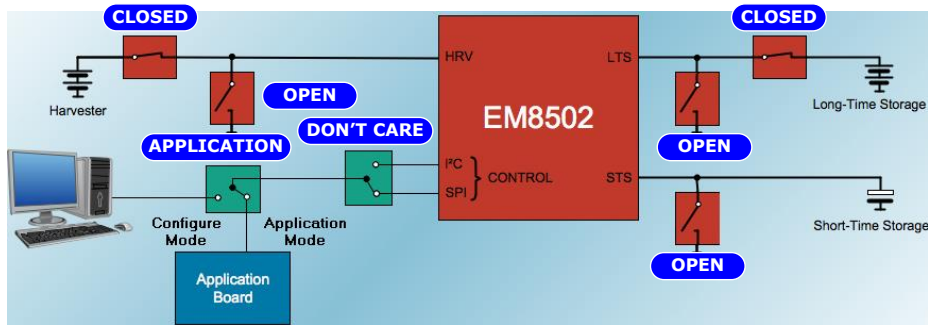

- | Click on the **A/D measurement button** to observe measured voltages.

Select Measure window

Start A/D measurement

EM8502 Development Explorer

Configure | Measure | Visualize | Activity

0.5104 V (HRV LOW = HI Z)

1.4006 V (BAT LOW = HI Z)

1.7273 V

2.4660 V

0.0009 V (VSUP)

0.4218 V (VALUX 0)

0.3049 V (VALUX 1)

0.3244 V (VALUX 2)

reg_status [0x22]	sw_vdcdc_lts_nsts	reg_vid_status [0x23]	sts_apl_max_hi	reg_lux_meter_result [0x1D]	lux_meter_result
eeeprom_data_busy	sw_lts_sts	lts_bat_min_hi	sts_apl_max_lo	Device Discovery	77h
hrv_lux_busy	usb_on	lts_bat_min_lo	sts_bat_min_hi		
hrv_low	lts_protect	sts_bat_max_hi	sts_bat_min_lo		
bat_low		sts_bat_max_lo			

Measurement started

USB connected

- | **Select the Visualize window**
- | **Click on the Graph 1 and/or Graph 2 “Click to add graphs” buttons to add the signals or thresholds that you want to observe in your graphical window**

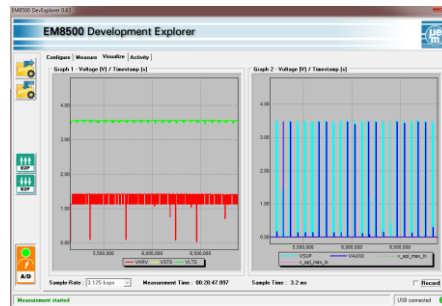
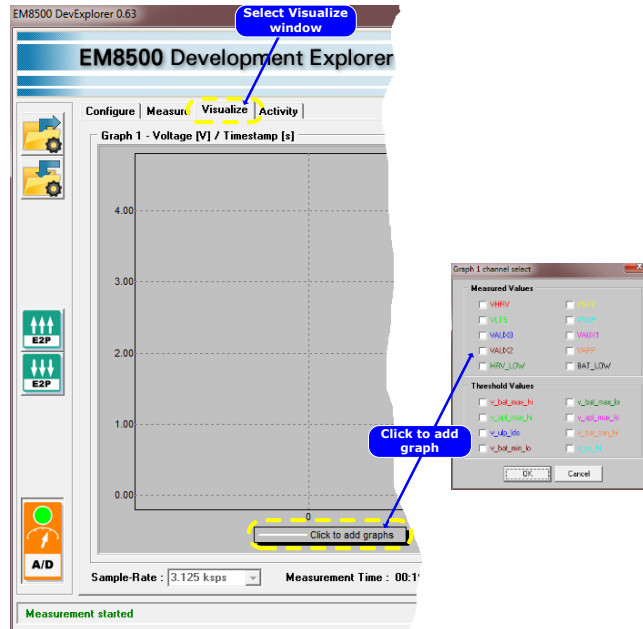

- The EM8500 DevExplorer Graph viewer tool allows you to navigate within the waveforms

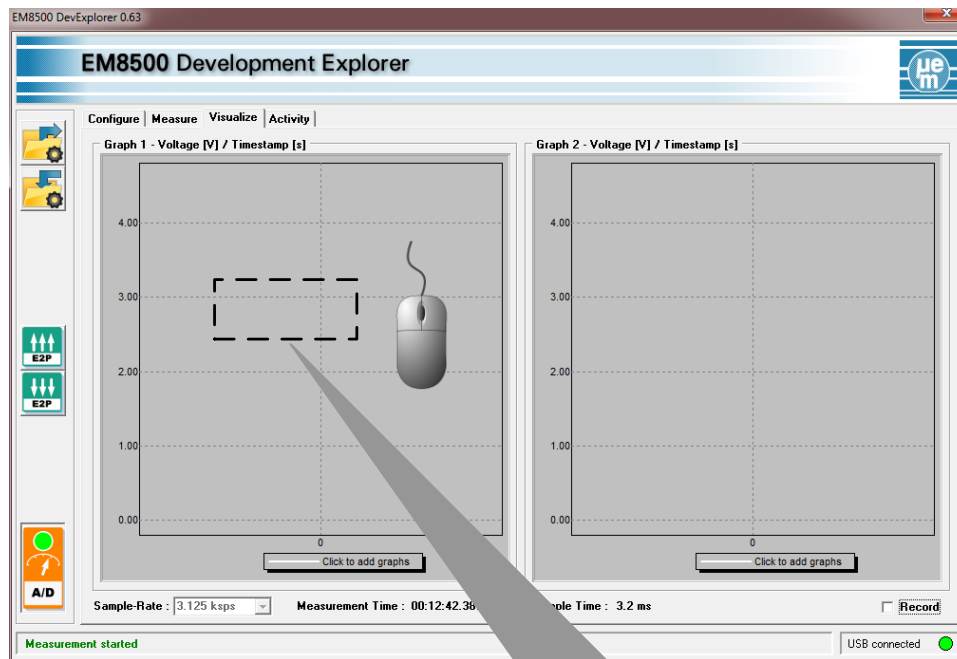

Mouse viewer tool

- Zoom-In : Mark top-left to bottom right
- Zoom-Out : Mark bottom-right to top left
- Move: Hold down right mouse button
- Select : Click legend to select channels

EM Microelectronic-Marín SA ("EM") makes no warranties for the use of EM products, other than those expressly contained in EM's applicable General Terms of Sale, located at <http://www.emmicroelectronic.com>. EM assumes no responsibility for any errors which may have crept into this document, reserves the right to change devices or specifications detailed herein at any time without notice, and does not make any commitment to update the information contained herein.

No licenses to patents or other intellectual property rights of EM are granted in connection with the sale of EM products, neither expressly nor implicitly.

In respect of the intended use of EM products by customer, customer is solely responsible for observing existing patents and other intellectual property rights of third parties and for obtaining, as the case may be, the necessary licenses.

Important note: The use of EM products as components in medical devices and/or medical applications, including but not limited to, safety and life supporting systems, where malfunction of such EM products might result in damage to and/or injury or death of persons is expressly prohibited, as EM products are neither destined nor qualified for use as components in such medical devices and/or medical applications. The prohibited use of EM products in such medical devices and/or medical applications is exclusively at the risk of the customer